

Planning For & Ordering Edgeband

See Page 2 for location of specific edgebands for each Series or furniture type.

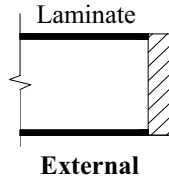

When choosing an edgeband for continuous tops you can either have the edgeband placed internally (the edgeband captured by the laminate) or externally (the laminate captured by the edge band)

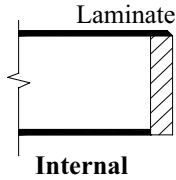
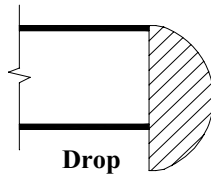
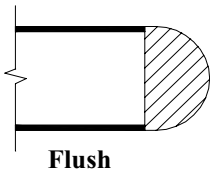

When choosing an edgeband for continuous tops you can either have the edgeband placed flush with the bottom of the top or dropped below the bottom.

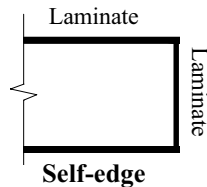

When choosing an edgeband for continuous tops you can have a laminate edgeband matching the laminate top (self-edge). All edges and corners are finished for maximum “bump” protection.

Edgeband Options for Top Thicknesses

(Note: top thickness is specified by unit)

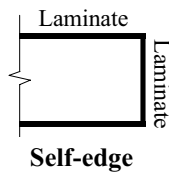
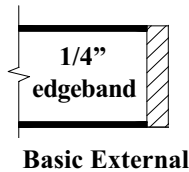
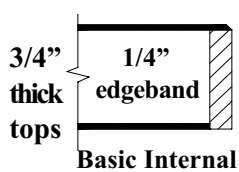

3/4 inch thick tops are only offered with a BASIC 1/4 inch T solid wood internal or eternal edgeband or the matching laminate (self-edge.)

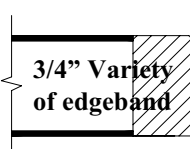
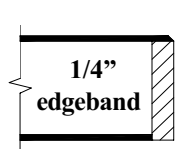
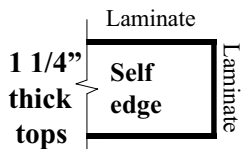

1-1/4 inch thick tops can be constructed with a laminated (self edge) OR 1/4 inch T Internal BASIC solid wood edgeband OR 3/4 inch T solid wood with a variety of internal or external edgeband details.

Edgebands

Edgeband Details.

All Russwood units using veneer plywood receive a edgeband on all exposed edges. Familiarize yourself with these standard edgeband shapes and terms as your order may require that you choose one of these edgebands.

See Table of Contents for location of specific edgebands for each Series or furniture type.

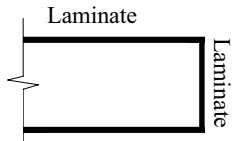

Self Edge
3/4" thick top OR
1-1/4" thick top



3/4" thick top (Internal)
Basic Flush

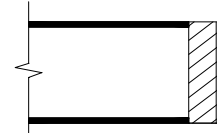

3/4" thick top (External)
Basic Flush External

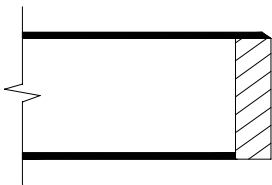

1 1/4" thick top (Internal)
Basic Flush

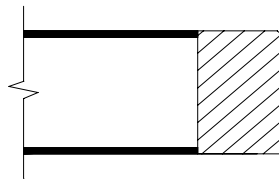

1 1/4" thick top (External)
Montana Flush

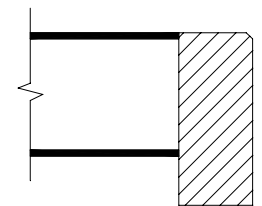

1 1/4" thick top (External)
Montana Drop

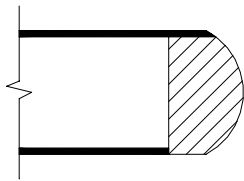

1 1/4" thick top (Internal)
Shallow Bullnose Flush



1 1/4" thick top (Internal)
Shallow Bullnose Drop

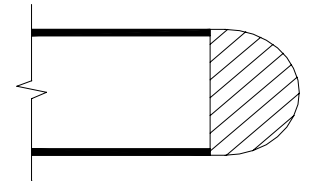

1 1/4" thick top (External)
Bullnose Flush

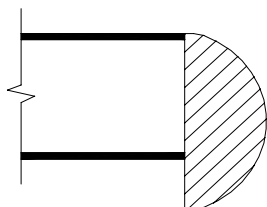

1 1/4" thick top (External)
Bullnose Drop

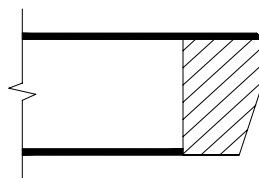

1 1/4" thick top (Internal)
Premier Flush

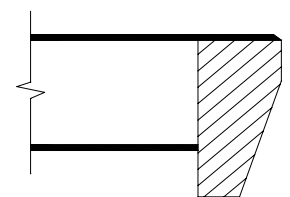

1 1/4" thick top (Internal)
Premier Drop

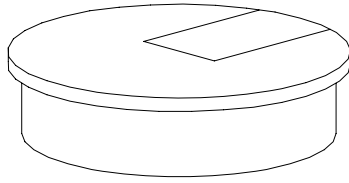

Grommet

3" diameter grommet with 7/8"W retractable tab. Grommet fits into a sleeve. Grommet has an inside diameter of 2-1/2" and is made for a 2-3/4" diameter opening. The grommet is made of molded black ABS.

Catalog #	Description	Height"	Diameter"	Price
A-01	Electrical Grommet (2 Piece)	3/4"	3"	

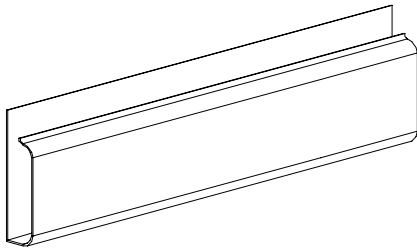

J-Channel Wire Manager

Wire manager is made out of J-shaped, molded black ABS plastic. Wire manager is easy to install using staples or screws and can be mounted both horizontally and vertically.

Catalog #	Description	Height"	Width"	Depth"	Price
A-03	J-Channel Wire Manager	4"	per foot"	1"	per foot

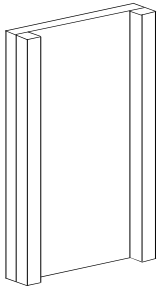

Solid-Wood Wire Chase

This option is designed to work in conjunction with the wire grommet to further conceal wiring. The chase must be priced and specified on the order form if desired. Grommets and wire manager are custom positioned in each unit to ensure concealment.

Catalog #	Description	Height"	Width"	Depth"	Price
A-04	Solid-wood Wire-Chase	customized per unit	4"	1-1/4"	

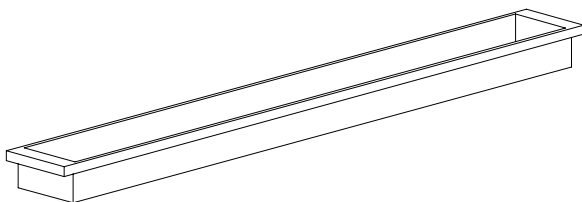

Computer Paper Grommet

18"L x 2"W paper grommet with locator pins for fixed placement. Inside dimensions are 17"L x 1-3/4"W and is made for a 17-1/4"L x 1-7/8"W opening.

Catalog #	Description	Height"	Width"	Depth"	Price
A-02	Paper-Feed Grommet	1"	18"	2"	

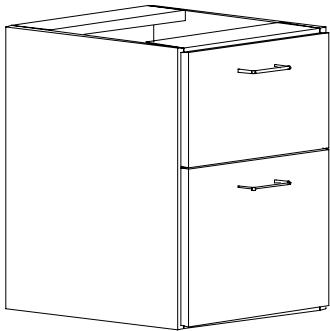

Hanging File Drawer Pedestal

This pedestal unit has one (1) box drawer and one (1) file drawer. The file drawer is 14-7/8"W x 10-1/2"H x 18"D and the box drawer is 14-7/8"W x 5-1/4"H x 18" D. Each drawer is constructed with a Satin Chrome Wire-Pull drawer handle. 3/4" oak veneer plywood and edgedbanded with 1/4"T solid oak on all exposed edges.

Catalog #	Description	Height"	Width"	Depth"	Price
A-19	Hanging File Drawer Pedestal	22-3/4"	17-3/8"	19-3/4"	

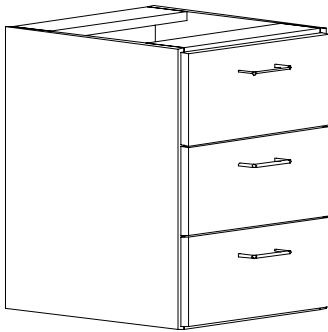

Hanging Three Drawer Pedestal

This pedestal unit has three (3) equal size box drawers. Each box drawer is 14-7/8"W x 5-1/4"H x 18" D and is constructed with a Satin Chrome Wire-Pull drawer handle. 3/4" oak veneer plywood and edgedbanded with 1/4"T solid oak on all exposed edges.

Catalog #	Description	Height"	Width"	Depth"	Price
A-19-3	Hanging Three Drawer Pedestal	22-3/4"	17-3/8"	19-3/4"	

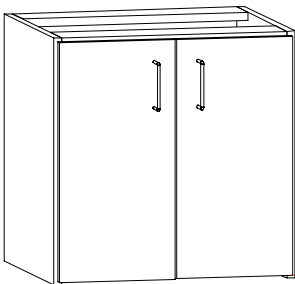

Hanging Cupboard Pedestal

This pedestal is constructed from 3/4"T oak veneer plywood and edgedbanded with 1/4"T solid oak on all exposed edges. Unit has (1) adjustable shelf and is enclosed by two equal size doors with satin chrome wire-pull drawer handles. Adjustable shelf size for the A-42 is 31-1/2"W x 18"D x 3/4"T and for the A-43 is 19-1/2"W x 18"D x 3/4"T.

Catalog #	Description	Height"	Width"	Depth"	Price
A-42	Hanging Cupboard for 72"L Credenza	22-3/4"	33-1/4"	19-3/4"	
A-43	Hanging Cupboard for 60"L Credenza	22-3/4"	21-1/4"	19-3/4"	

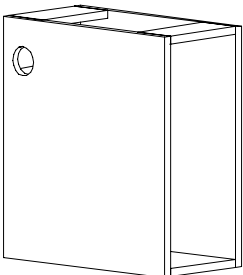

Hanging CPU Cabinet

CPU Cabinet can be custom positioned within desk or credenza unit. This pedestal is constructed of 3/4" oak veneer plywood and edgedbanded with 1/4"T solid oak on all exposed edges. Internal dimensions are 20"D x 9"W x 16"H.

Catalog #	Description	Height"	Width"	Depth"	Price
A-18	Hanging CPU Cabinet	22-3/4"	10-1/2"	20-3/4"	

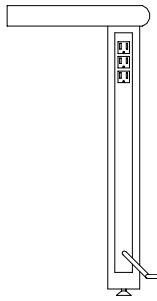

Three Outlet Power Leg

Optional power leg is made of solid matching hardwood with a flush-mounted, UL-approved power strip. Power strip has three outlets and is supplied with a five-foot cord.

Catalog #	Description	Height"	Width"	Depth	Price
A-925	Power Leg for 25"H Table	25	2-14"	2-1/4"	
A-927	Power Leg for 27"H Table	27	2-14"	2-1/4"	
A-929	Power Leg for 29"H Table	29	2-14"	2-1/4"	
A-939	Power Leg for 39"H Table	39	2-14"	2-1/4"	

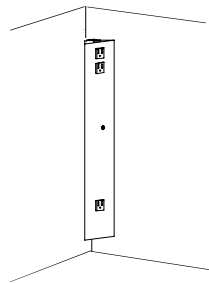

Three Outlet Corner Power Column

Designed to fasten in the corner of any paneled unit or tables with aprons. Power column has a 15-AMP rating, local circuit breaker and three outlets. Unit attaches vertically or horizontally with concealed screws.

Catalog #	Description	Height"	Width"	Depth"	Price
A-12	Power Column for Corners	4"	per foot"	1"	

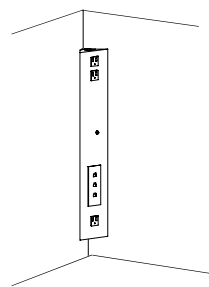

**Three Outlet /Three RJ45's
Corner Power Column**

Designed to fasten in the corner of any paneled unit or tables with aprons. Power column has a 15-AMP rating, local circuit breaker and three outlets. Unit attaches vertically or horizontally with concealed screws. Unit also contains (3) RJ45 ports.

Catalog #	Description	Height"	Width"	Depth"	Price
A-12RJ	3 Outlet 3 RJ45's Corner Power Outlet	20"	4-1/4"	1-1/2"	

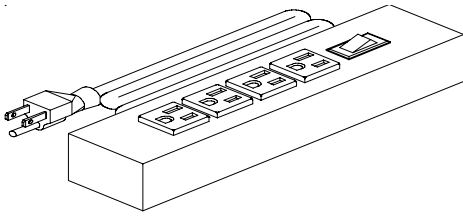

4 Outlet Power Strip

Power strip is UL listed, has four outlets and circuit breaker with reset switch. Strip features full surge protection with indicator light and six-foot cord.

Catalog #	Description	Height"	Length"	Width"	Price
A-13	4 Outlet Power Strip	1-7/8"	9-1/2"	2"	

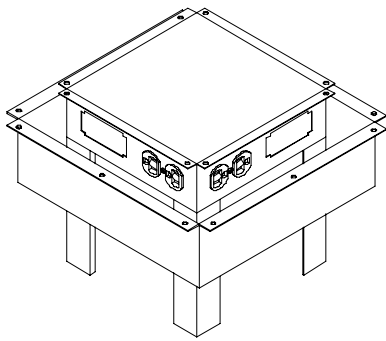

Retracting Four Sided Power Data Center

Manual lift w/4 duplexes, 4 RJ-11, 4 RJ-45, 72" cord with molded plug, 15 amp circuit breaker.

Catalog #	Description	Length"	Width"	Price
A-33	Retracking 4 Sided Power Data Center	11-3/8"	11-3/8"	

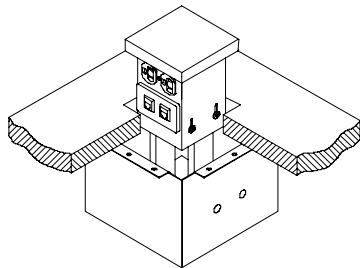

Retracting Two Sided Power Data Center

Manual lift w/ 2 duplexes, 2 RJ-11, 2 RJ-45, 72" cord with molded plug, 15 amp circuit breaker.

Catalog #	Description	Length"	Width"	Price
A-40	Retracking 2 Sided Power Data Center	5"	5"	

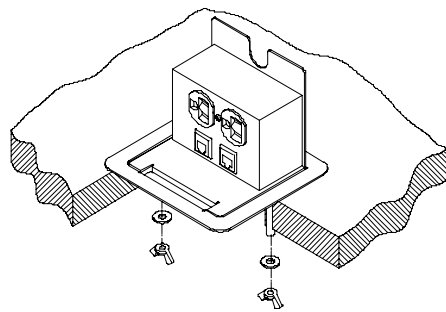

Flip Up Power Data Center

Black textured finish. Table top flip up unit w/ 1 duplex, 1 RJ-11 cat 3, 1 RJ-45 cat 6, 72" cord with molded plug.

Catalog #	Description	Length"	Width"	Price
A-41	Flip Up Power Data Center	4-1/2"	4-1/2"	

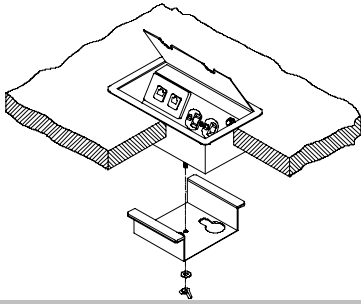

Recessed Power Data Center (Single)

Black textured finish. Table top unit w/1 duplex, 72" cord with molded plug, 15 amp circuit breaker, 3rd receptacle on bottom for Convenience outlet, 1 configurable telecom plate ordered separately

Catalog #	Description	Length"	Width"	Price
A-36	Recessed Power Data Center (Single)	8-1/4"	4-5/8"	

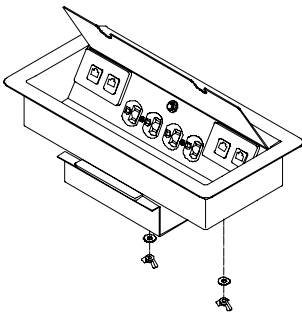

Recessed Power Data Center (Double)

Black textured finish. Table top unit w/ 2 duplexes, 72" cord with molded plug, 15 amp circuit breaker, 2 configurable telecom plates ordered separately.

Catalog #	Description	Length"	Width"	Price
A-37	Recessed Power Data Center (Double)	13-1/2"	6"	

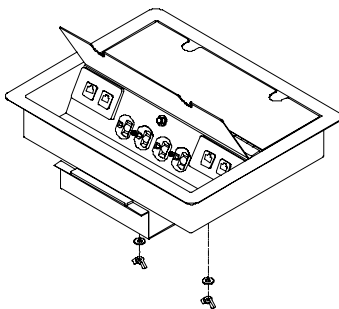

Recessed Power Data Center (Quad)

Black textured finish. Table top unit w/ 4 duplexes, 72 " cord with molded plug, 15 amp circuit breaker, 4 configurable telecom plates ordered separately

Catalog #	Description	Length"	Width"	Price
A-38	Recessed Power Data Center (Quad)	13-1/2"	11"	

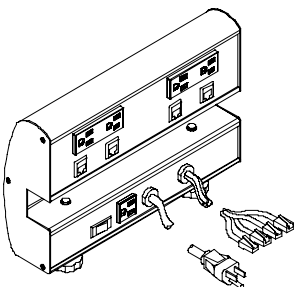

Removable Power Data Center

Black textured finish. Clamp on voice/data/power for training tables w/2 duplex, 2 RJ-11 cat 3, 2 RJ-45 cat 6, 72" cord with molded plug, 4- 60" patch cords for telecom wiring, lighted ON/OFF switch- circuit breaker, 5th receptacle on bottom for convenience outlet.

Catalog #	Description	Height"	Length"	Width"	Price
A-39	Removable Power Data Center	7-3/4"	10"	2-7/8"	

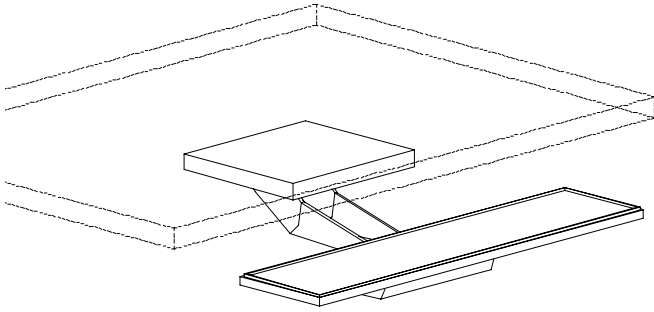

Articulating Keyboard Tray

Keyboard pullout consists of metal articulating arm with matching keyboard tray. Key board tray retracts and is adjustable left to right and up and down.

Catalog #	Description	Height"	Width"	Depth"	Price
A-16	Articulating Pull Out Keyboard Tray	6"	20-15/16"	25"	

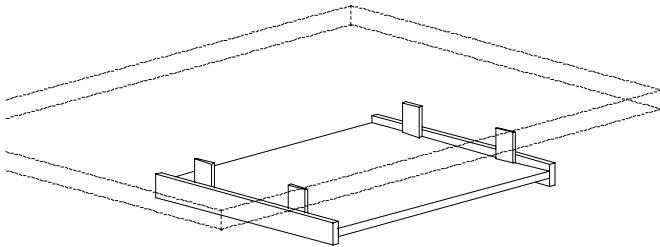

Pull-Out Keyboard Tray

The Pullout Keyboard Tray consists of metal ball-bearing glides fastened to a 3/4" T oak veneer plywood tray. The tray size is 20"W x 16"D and is edgedbanded on the front edge with 1/4" T solid oak.

Catalog #	Description	Height"	Width"	Depth"	Price
A-17	Pullout Tray for keyboard	4-1/2"	20"	16"	
A-17-M	Pull out Tray for keyboard and mouse	4-1/2"	28"	16"	



Flap Down Keyboard Tray

This key board tray is constructed with 1/2" T solid oak. The front is 3/4" T solid oak. The key board tray pulls out and the front tilts 90 degrees for keyboard access.

Catalog #	Description	Height"	Width"	Depth"	Price
A-40	Flap Down Keyboard Tray	4-1/4"	28"	18"	

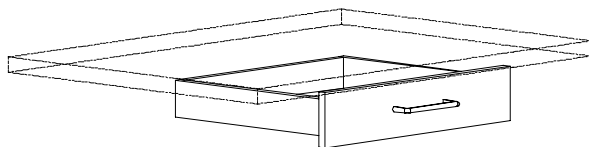

Pencil Drawer

Pencil drawer can be mounted under any desk or return arrangement where space permits. Pencil drawer inside dimensions are 17"W x 13-7/8"D x 3"H. Drawer pull is satin chrome. Drawer is mounted with full extension ball bearing glides.

Catalog #	Description	Height"	Width"	Depth"	Price
A-20	Pencil Drawer	4-1/4"	20"	18-3/4"	

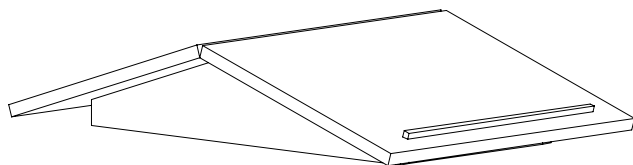

**Revolving Dictionary Stand
(Single or Double)**

Each stand will have full 360-degree rotation capability on a ball-bearing supported base with protective material. The sloped top will have a retaining strip attached to the lower end.

Catalog #	Description	Height"	Width"	Depth"	Price
RDS-112	Single-faced stand	5	21	18	
RDS-118	Double-faced stand	5	21	35	



Task Light

Task light is supplied with 20-watt fluorescent bulb, plastic diffuser lens and push-switch power interrupter. Unit mounts horizontally and is supplied with a 72" cord to be plugged into power strip accessories.

Catalog #	Description	Height"	Width"	Length"	Price
A-15	Task Light	1"	4-1/2"	12"	

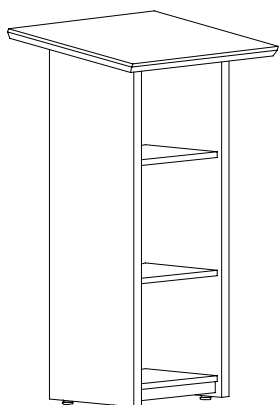

Podium

This accessory provides an angled surface with a retaining strip at the bottom. Three non-adjustable shelves are built in to the base. 3/4" oak veneer plywood and edgebanded on all exposed edges.

Catalog #	Description	Height"	Width"	Depth"	Price
A-32	Podium	46"	20"	15"	

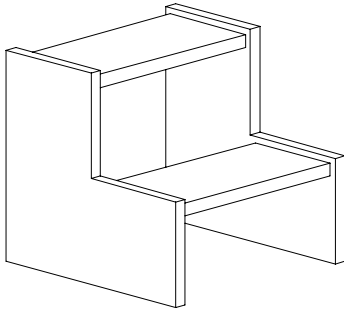

Step Stool

Step stool is 3/4" oak veneer plywood and edgebanded on all exposed edges.

18"W x 16-1/2"H x 24"D.

Catalog #	Description	Height"	Width"	Depth"	Price
A-22	Step Stool	16-1/2"	18"	18"	

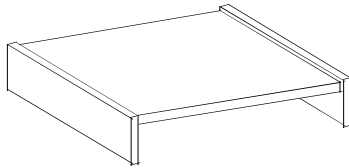

Desktop Monitor Stand

Monitor stand is designed to support up to a 21" monitor with keyboard storage provided within stand assembly. 3/4" oak veneer plywood and edgebanded on all exposed edges. Inside dimensions are 20"W x 9"D x 3-1/4"H.

Catalog #	Description	Height"	Width"	Depth"	Price
A-21	Desk-top Monitor Stand (Repositionable)	4-1/2"	22-3/4"	14"	



Rubber Corner Bumper

High density rubber bumper. Grey in color. Attached to corner with (8) wood screws. Bumper are generally used on mobile units.

Catalog #	Description	Length	Width"	Depth"	Price
A-47	One Rubber Corner Bumper	11-1/2"	1-3/16"	1-3/16"	